



**Stalwart
Meditech**

Stalwart Meditech Pvt Ltd

Corporate off: Plot no: A10, Second Floor, Patparganj Industrial Area, Delhi-110092

Registered office: 4/2544, Main Road, street No-11, Behari Colony, Shahdara, Delhi-110032

Mob: +91-99999012763, 9718784245

Landline: 011-49869776

Email: stalwartmeditechindia@gmail.com

ENDOSCOPE SERIES

SURGICAL INSTRUMENTS

Laparoscopic Instruments

Laparoscope

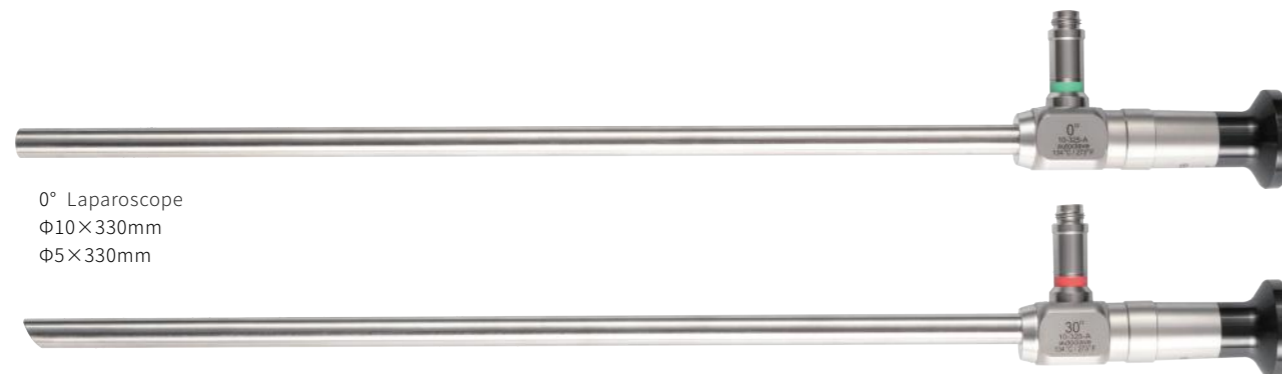

0° Laparoscope
Φ10×330mm
Φ5×330mm

30° Laparoscope
Φ10×330mm
Φ5×330mm

Trocar and Sealing Cap

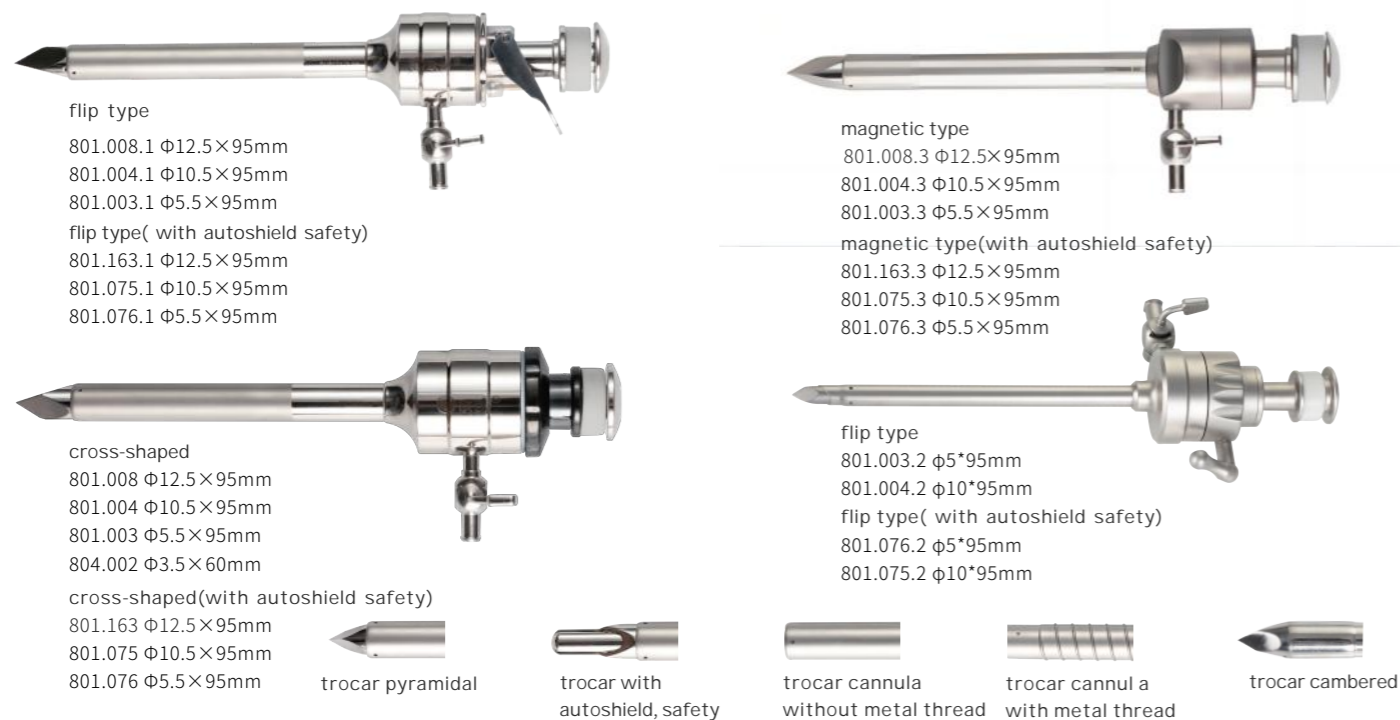

flip type
801.008.1 Φ12.5×95mm
801.004.1 Φ10.5×95mm
801.003.1 Φ5.5×95mm
flip type(with autoshield safety)
801.163.1 Φ12.5×95mm
801.075.1 Φ10.5×95mm
801.076.1 Φ5.5×95mm

magnetic type
801.008.3 Φ12.5×95mm
801.004.3 Φ10.5×95mm
801.003.3 Φ5.5×95mm
magnetic type(with autoshield safety)
801.163.3 Φ12.5×95mm
801.075.3 Φ10.5×95mm
801.076.3 Φ5.5×95mm

flip type
801.003.2 Φ5*95mm
801.004.2 Φ10*95mm
flip type(with autoshield safety)
801.076.2 Φ5*95mm
801.075.2 Φ10*95mm

cross-shaped
801.008 Φ12.5×95mm
801.004 Φ10.5×95mm
801.003 Φ5.5×95mm
804.002 Φ3.5×60mm
cross-shaped(with autoshield safety)
801.163 Φ12.5×95mm
801.075 Φ10.5×95mm
801.076 Φ5.5×95mm

trocar pyramidal

trocar with autoshield, safety

trocar cannula without metal thread

trocar cannula with metal thread

trocar cambered

802.008, trocar with metal thread, Φ5.5mm

802.009, trocar with metal thread, Φ8.5mm

802.010, trocar with metal thread, Φ10.5mm

802.011, trocar with metal thread, Φ12.5mm

801.108 new threaded trocar Φ5.5×88mm

801.109 new threaded trocar Φ10.5×88mm



801.086.2, Φ10.5mm sealing cap/washer

801.086.1, Φ5.5mm sealing cap/washer

801.086, Φ3mm sealing cap/washer

Reducer

801.010 sleeve type, Φ10.5-Φ5.5mm



801.010 100mm
801.010.1 120mm
801.010.2 150mm
801.010.3 170mm



801.010.4 22mm



801.145 bayonet type
Φ10.5-Φ5.5mm



801.146 screw type
Φ10.5-Φ5.5mm

Veress Needle

801.027 Φ5×330mm



801.027.1 7#

801.027.2 9#

801.027.3 16#

801.027.4 18#

801.027.5 20#

801.027.6 22#

Bile duck Knife



801.025

801.025 Φ5×330mm

801.025.1

801.026

801.026 Φ10×330mm

Monopolar HF Electrode

Φ5×330mm



808.017 monopolar hook electrode "L"

808.017.1 monopolar sharp "L" hook

808.017.2 monopolar electric hook

808.017.3 monopolar hook electrode "J"

808.021.1 monopolar electric knife

808.018.1 monopolar coagulation

808.019.1 monopolar electric spade

808.020.1 monopolar electric pin

Veress Needle

- 801.011 $\Phi 2.2 \times 110\text{mm}$
- 801.011.1 $\Phi 2.2 \times 120\text{mm}$
- 801.011.2 $\Phi 2.2 \times 150\text{mm}$

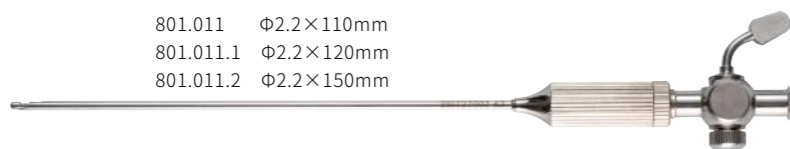

801.231 Veress Needle Connector



Suction & Irrigation

$\Phi 5/\Phi 10 \times 330\text{mm}$

- 801.079 push type
- 801.079.1 push type(big valve)
- 801.079.2 push type(small valve)



$\Phi 5/\Phi 10 \times 330\text{mm}$

- 801.149 spring type



5mm Golden Scissors

- 801.033.1JB Golden Scissors

$\Phi 5 \times 330\text{mm}$



Bipolar

$\Phi 5 \times 330\text{mm}$

- 808.044 Bipolar Forceps (screwed)



808.044 double action (straight)



808.044.1 double action (curved)

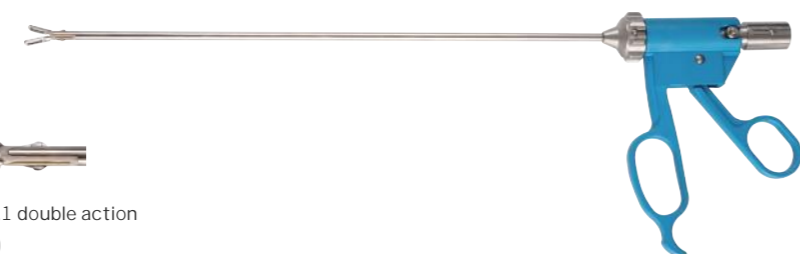

$\Phi 5 \times 330\text{mm}$

- 808.045 Bipolar Forceps (three partition)



808.045 single action (straight)



808.045.2 single action (curved)



808.045.4 single action (blunt shaped)



808.045.5 single action (round shaped)

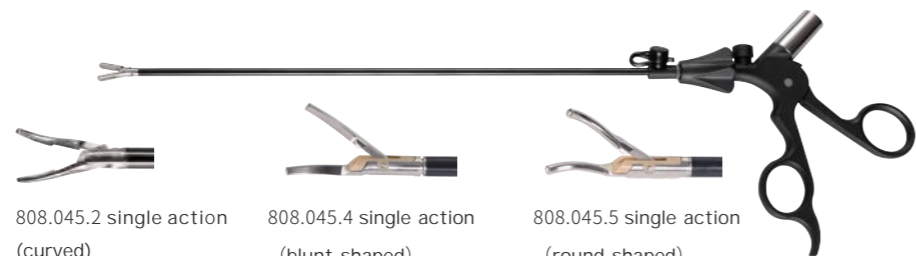

808.045.1 double action (straight)

808.045.3 double action (curved)

Cord for Monopolar



808.082 Cord for Monopolar $\Phi 4 \times 3000\text{mm}$



808.082.1 match OLYMPUS $\Phi 8\text{mm}$



808.082.2 ordinary connector $\Phi 6\text{mm}$



808.082.6 match HUTONG $\Phi 6.3\text{mm}$

Cord for Bipolar



808.039 Cord for Bipolar 3000mm (match three partition handle)



808.039.1 Cord for Bipolar (match blue handle)

Clip Applier, Polymer Ligation Clip



801.113, XL, $\Phi 10 \times 330\text{mm}$, matches 805.621

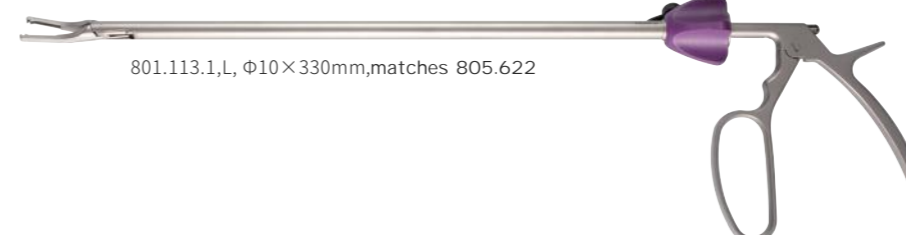

801.113.1,L, $\Phi 10 \times 330\text{mm}$, matches 805.622

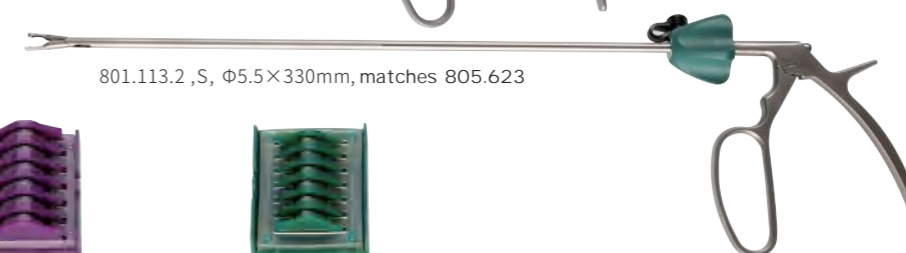

801.113.2,S, $\Phi 5.5 \times 330\text{mm}$, matches 805.623



805.621, XL



805.622, L



805.623, S

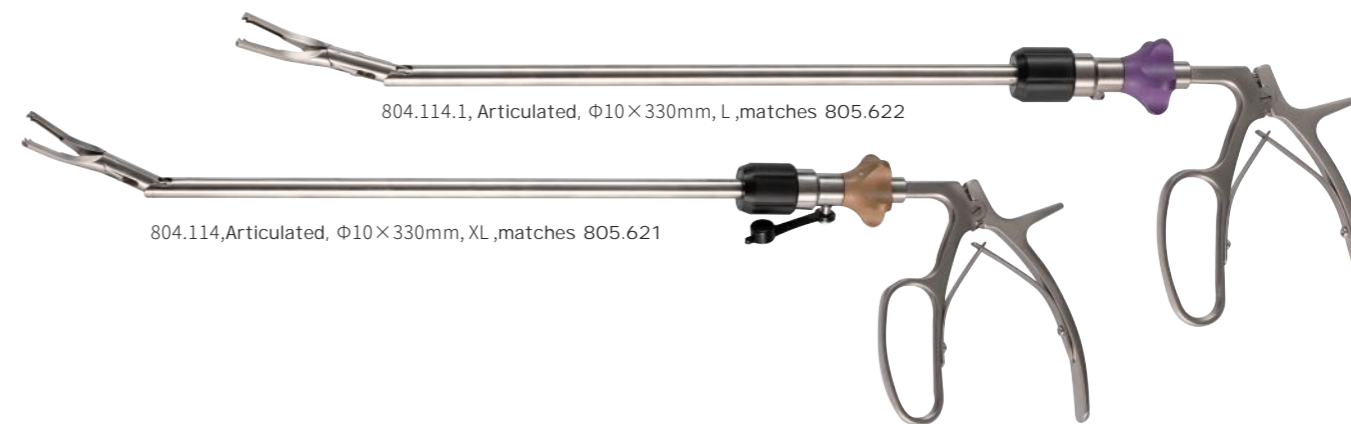

804.114.1, Articulated, $\Phi 10 \times 330\text{mm}$, L, matches 805.622

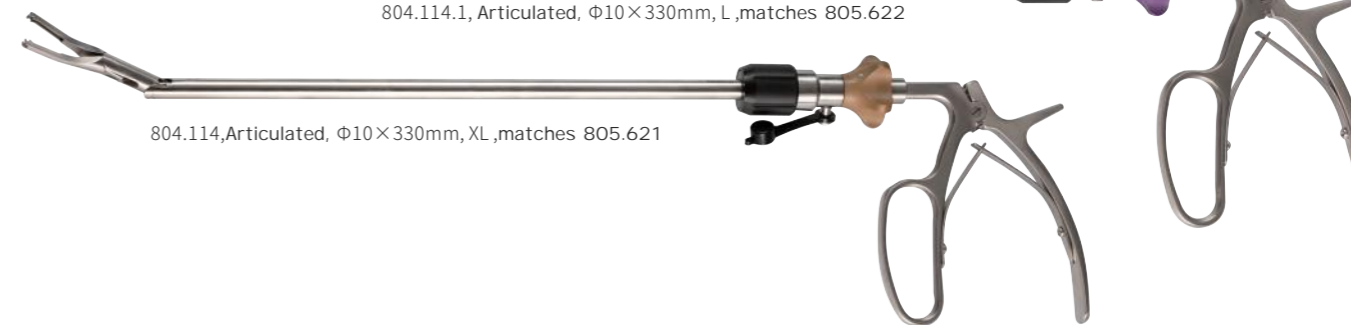

804.114, Articulated, $\Phi 10 \times 330\text{mm}$, XL, matches 805.621

Open Clip Applier



801.138 L/M/ML
801.138.3 S

Open Clip Applier



801.115 ,XL,matches 805.621

801.115.1,L, matches 805.622

801.115.2 ,S, matches 805.623

Clip Remover



801.131.1 ,XL,Φ10×330mm

801.131 ,L ,Φ5×330mm

Titanium Clip, Clip Applier



805.611,L
04#

805.612,M/L
03#

805.613,M
02#

805.614,S
01#

805.612
(03#)

805.613
(02#)

805.614
(01#)

801.001, single action,L,Φ10×330mm



801.001.1 single action,L
Φ10×330mm

801.001.2 single action,M
Φ10×330mm

801.001.3 single action,M/L
Φ10×330mm

801.002 ,right triangle, M/L
Φ10×330mm

801.111 ,double action,M/L
Φ10×330mm

804.001, single action, S
Φ5×330mm

Open Clip Applier



801.132 eight teeth
801.132.1 nine teeth

Artery/Vein Clip,Clip Applier

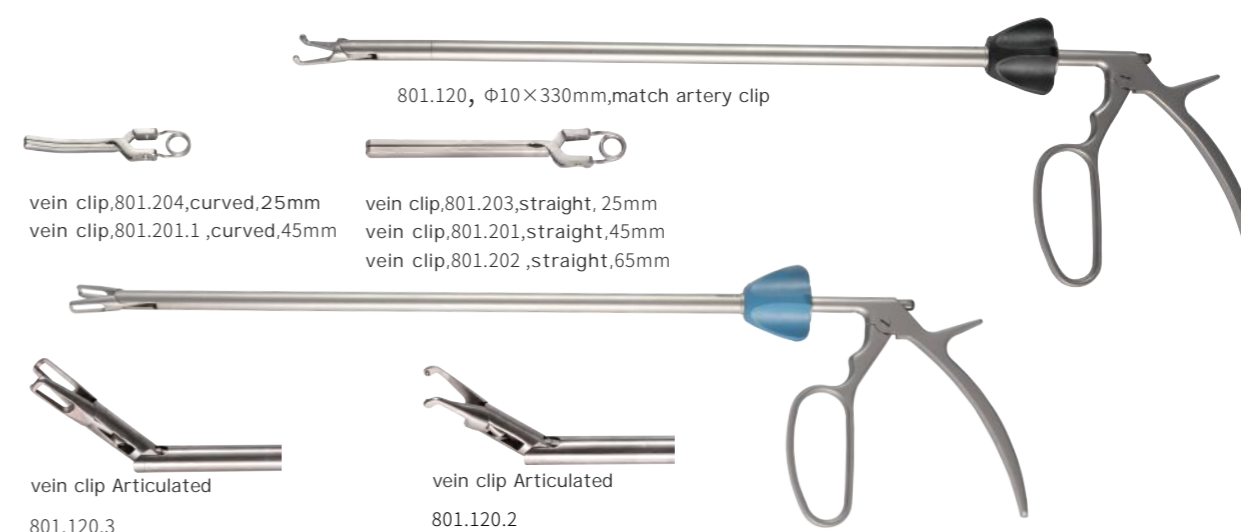

801.120, Φ10×330mm,match artery clip

vein clip,801.204,curved,25mm
vein clip,801.201.1 ,curved,45mm

vein clip,801.203,straight, 25mm
vein clip,801.201,straight,45mm
vein clip,801.202 ,straight,65mm

vein clip Articulated
801.120.3

vein clip Articulated
801.120.2

Knot Pusher



801.029 metal head
Φ5×330mm

801.029.1 plastic head
Φ5×330mm

801.029.2 crescent shaped
Φ5×330mm

801.029.3 core pulling
Φ5×330mm

801.029.4 slot type
Φ5×330mm

Clip Applier

801.112 with bio-absorbable Tyco clip applier
Φ10×330mm

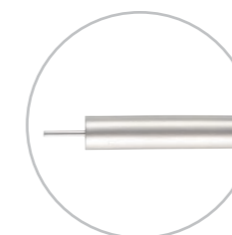

Needle Holder



A-shaped needle holder (Titanium alloy) $\Phi 5 \times 330\text{mm}$
 801.101 straight
 801.101.1 curved
 801.101.2 self-righting
 801.101.3 wire clipping
 801.101.4 self-righting(arc)

O-shaped $\Phi 5 \times 330\text{mm}$
 801.022 straight
 801.022.1 curved
 801.022.2 self-righting
 801.022.3 wire clipping
 801.022.4 self-righting(arc)

V-shaped light $\Phi 5 \times 330\text{mm}$
 801.023 straight
 801.023.1 curved
 801.023.2 self-righting
 801.023.3 wire clipping
 801.023.4 self-righting(arc)

V-shaped heavy $\Phi 5 \times 330\text{mm}$
 801.024 straight
 801.024.1 curved
 801.024.2 self-righting
 801.024.3 wire clipping
 801.024.4 self-righting(arc)

V-shaped (Titanium alloy) $\Phi 5 \times 330\text{mm}$
 801.106 straight
 801.106.1 curved
 801.106.2 self-righting
 801.106.3 wire clipping
 801.106.4 self-righting(arc)

Gun shaped (Titanium alloy) \ (Stainless steel) $\Phi 5 \times 330\text{mm}$
 801.102 straight
 801.102.1 curved
 801.102.2 self-righting
 801.102.3 wire clipping
 801.102.4 self-righting(arc)



wire clipping straight curved self-righting self-righting(arc)

Closure Forceps

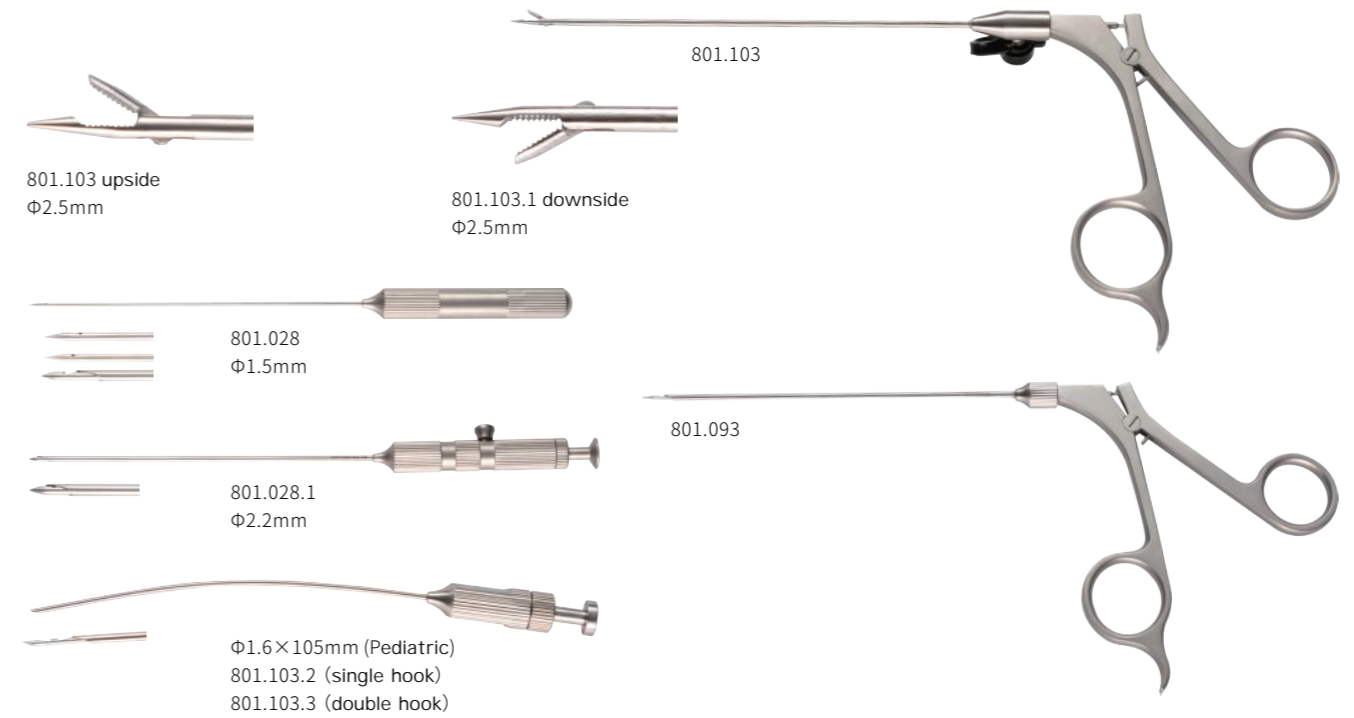

801.103
 801.103 upside $\Phi 2.5\text{mm}$
 801.103.1 downside $\Phi 2.5\text{mm}$

801.028 $\Phi 1.5\text{mm}$
 801.028.1 $\Phi 2.2\text{mm}$
 801.093
 $\Phi 1.6 \times 105\text{mm}$ (Pediatric)
 801.103.2 (single hook)
 801.103.3 (double hook)

Retractor



801.072.1 three leaves $\Phi 5 \times 350\text{mm}$

801.073.2 five leaves $\Phi 5 \times 350\text{mm}$

801.074 five leaves(bendable) $\Phi 10 \times 350\text{mm}$

801.092 five leaves $\Phi 10 \times 350\text{mm}$

Distraction Forceps(three leaves retractor)



801.066

Spring Grasping Forcep

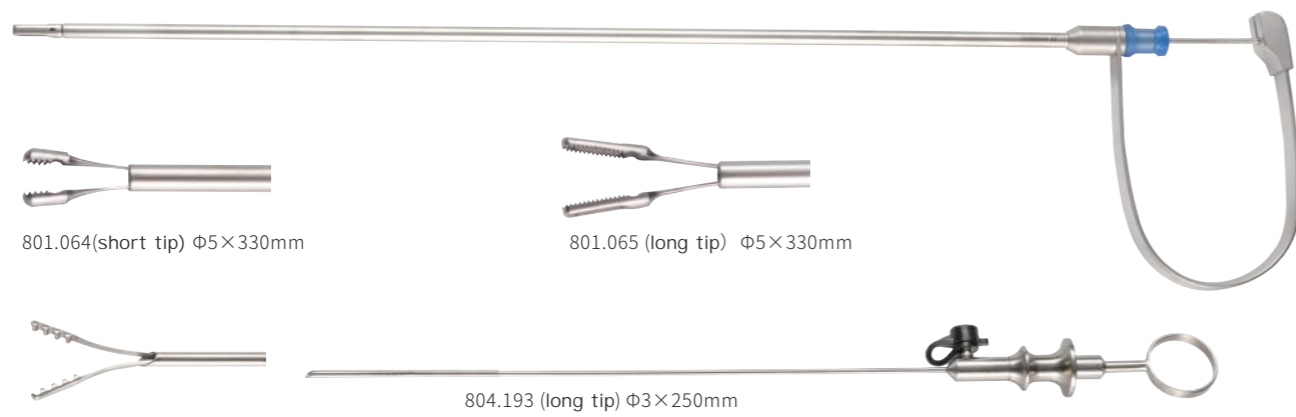

Biliary Tract-Lithotomy Forcep

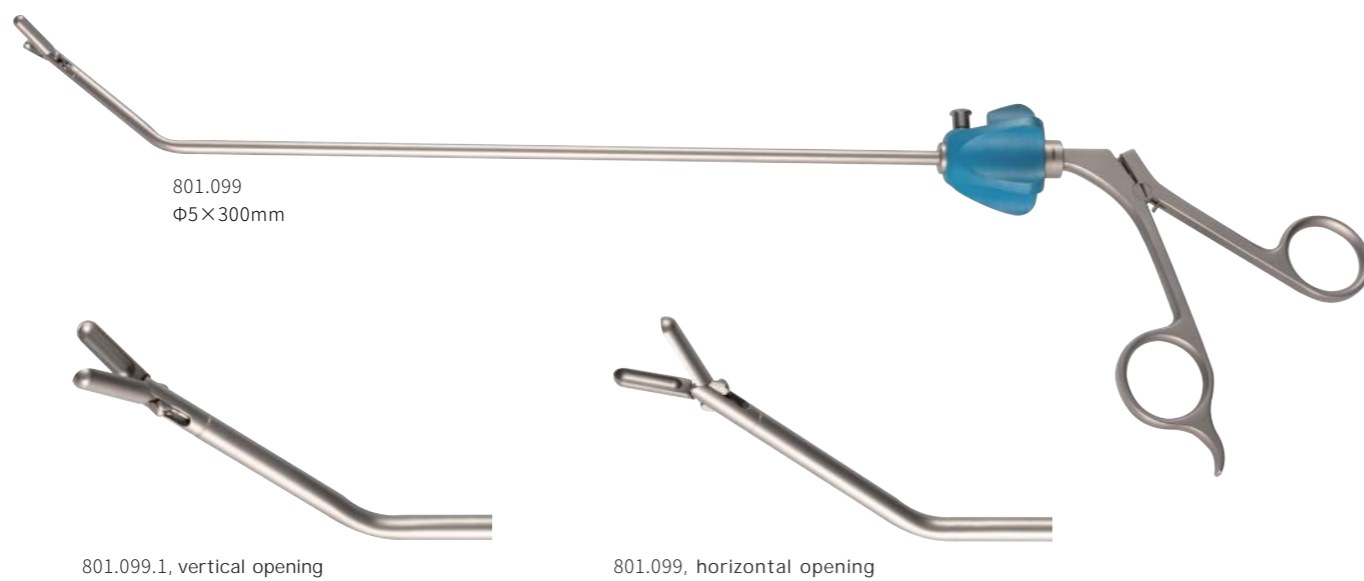

Golden Finger

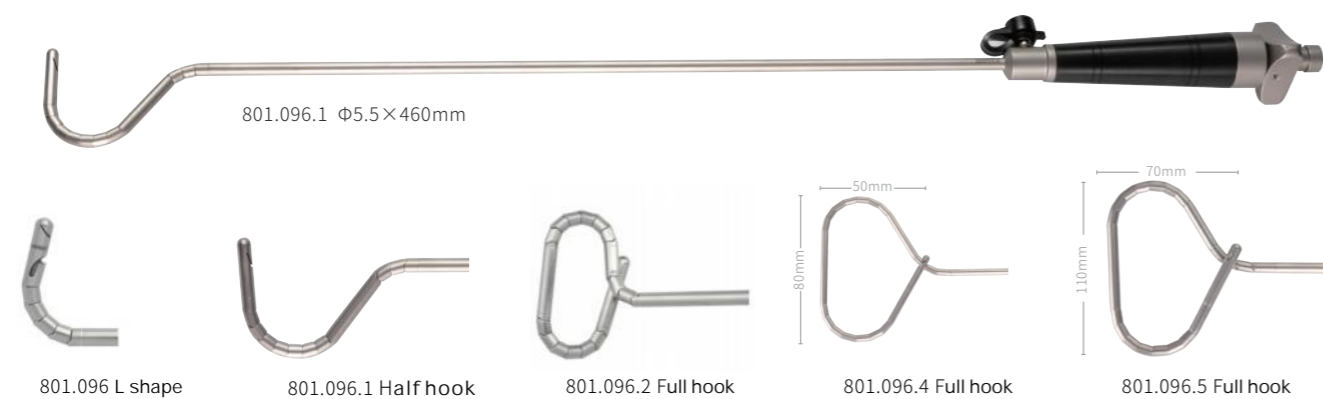

Vein/Nerve Retractor



Live Retractor

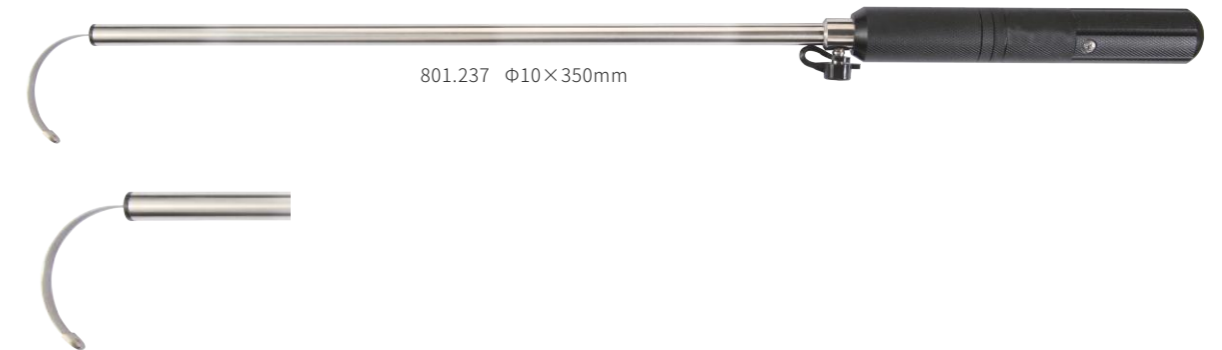

Bendable forceps



Angiographic grasping forceps

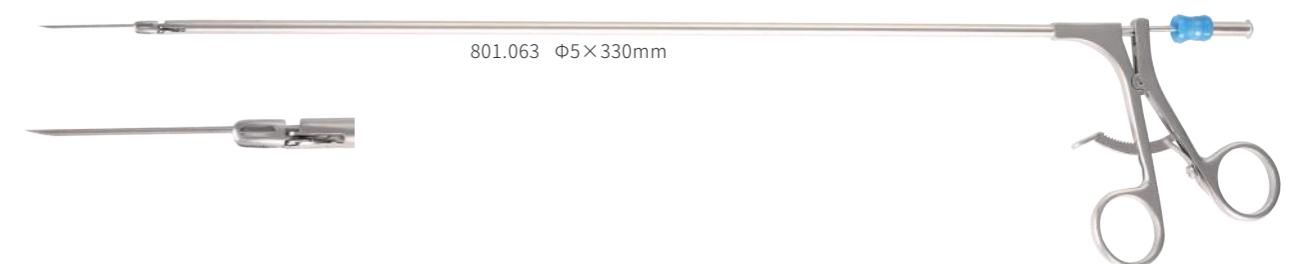

5mm Forceps & Scissors (5X330mm)

Handle Φ 5mm



801F.001 insulated handle



801F.002 insulated ratchet handle



801F.003 insulated handle (three partition)























801F.004 insulated handle (three partition, with ratchet)





















801F.013 insulated handle



801F.011 insulated ratchet handle

	801.032 straight scissors (single action)		801.133 claw forceps
	801.032.1 straight scissors (double action)		801.037 Maryland forceps 17mm
	801.033 curved scissors (single action)		801.037.1 Maryland forceps 12mm
	801.033.1 curved scissors (double action)		801.037.2 Maryland forceps 14mm
	801.033.2 micro-curved scissors (double action)		801.037.3 Maryland forceps 18mm
	801.034 hook scissors		801.037.4 Maryland forceps 20mm
	801.035 upwards scissors		801.037.5 Maryland forceps 25mm
	801.033.1B insulated scissors		801.037.6 blunt tip Maryland forceps 16mm
	801.036 straight grasper		801.037.7 Maryland forceps (45)
	801.051 dolphin nose grasper		801.037.8 Maryland forceps (70)

















	801.037.9 Maryland forceps (70) Mesh tooth		801.195.1 grasper 1+2 teeth, double action
	801.038 Mixer right angle		801.031 knot forceps
	801.038.1 Mixer right angle (wider head)		801.044.1 reverse-teeth forceps
	801.038.3 ligature clamp		801.047 cholecystic forceps
	801.037.1 insulated maryland forceps		801.047.1 nine teeth cholecystic forceps
	801.049 fenestrated grasping forceps		801.054 biopsy forceps sharp cupped jaw
	801.048.1 grasping forceps		801.105 claw forceps 2+4 teeth, single action
	801.048.2 grasping forceps		801.105.1 claw forceps 2+4 teeth, double action
	801.052 appendix grasping forceps		801.044.2 reverse-teeth forceps



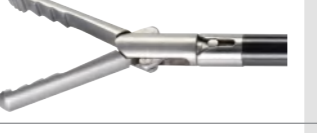

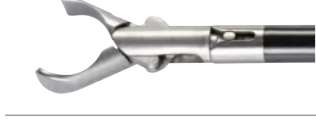





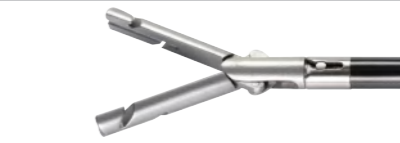







801F.005 stainless steel handle 801F.006 stainless steel(self-locking) 801F.008 stainless steel(with upper ratchet)



801F.007 mucous membrane forceps (with down ratchet)

	801.031.1 B-shaped knot forceps		801.050 bullet nose forceps
	801.062.1 V-shaped grasping forceps		801.057 fallopian tube grasping forceps
	801.061 O-shaped grasping forceps		801.042 duck-jaw grasping forceps
	801.198.1 stomach grasping forceps, curved		801.042.1 duck-jaw grasping forceps coarse teeth bowl shape
	801.134 babcock grasping forceps		801.043 Maxi grasper
	801.198 stomach forceps (double action)		801.044 reverse-teeth forceps
	801.055 biting&cutting forceps		801.046.1 grasper 2+3 teeth (double action)
	801.057.1 Oviduct forceps		801.058 mucous membrane forceps hollow
	801.053 cupped biopsy forceps		801.058.2 mucous membrane forceps

	801.030 knot forceps S shape		801.061 O-shaped grasping forceps
	801.059 hollow erect grasping forceps		801.056.1 Debakey grasping forceps (hollow)
	801.059.1 hollow erect grasping forceps, long tip		801.056 Debakey grasping forceps
	801.060.1 Allis grasper longer tip		801.072.2 sector forceps
	801.062 V-shaped grasping forceps		801.056.3 bowel forceps
	801.116 ureteral grasping forceps		801.045 organ-anchoring grasper
	801.048 atraumatic forceps		801.056.4 intestinal grasping forceps
	801.049.1 fenestrated grasping forceps		801.018.1 Walf claws grasping forceps
	801.049.2 endo(lap) clinch fenestrated grasper		

10mmx330mm Forceps and Scissors

Handle(Φ10mm)



801F.010 insulated handle
(two partition)



801F.012 insulated handle
(three partition)



801F.015 stainless steel handle, can not
be detached by hands (self-locked)















801F.016 stainless steel handle, can
not be detached by hands



801F.017 stainless steel handle, can not
be detached by hands (with down ratchet)

	801.012.2 biopsy forceps matches 801F.010		801.041.1 Mixer dissecting forceps matches 801F.010
	801.039.2 straight scissor matches 801F.010		801.040.2 curved scissors matches 801 F.010
	801.013.2 claw forceps only matches 801F.010		801.012 biopsy forceps matches 801F.016
	801.041 dissecting forceps (right angle) matches 801F.010		801.135 grasping forceps (eight claws) matches 801F.017
	801.041.2 Mixer dissecting forceps matches 801F.010		802.007 (duck-jaw grasping forceps) matches 801F.017
	801.013 claw forceps matches 801F.017		801.014 atraumatic forceps matches 801F.017

	801.069 stomach grasping forceps round tip, matches 801F.017		802.002 lobe grasping forceps
	801.071 anastomotic and tractive grasping forceps matches 801F.017		801.130 US Babcock grasper
	801.126 reverse teeth matches 801F.017		801.107 gut grasping forceps
	802.004 toothless grasping forceps (with wide mouth) matches 801F.017		802.005 grasping forceps
	801.121 oval grasping forceps matches 801F.017		801.235 interdiction vessel
	801.068 stomach grasping forceps matches 801F.017		801.070 suture grasping

OC-804 Miniature Instruments for children and paediatric surgery

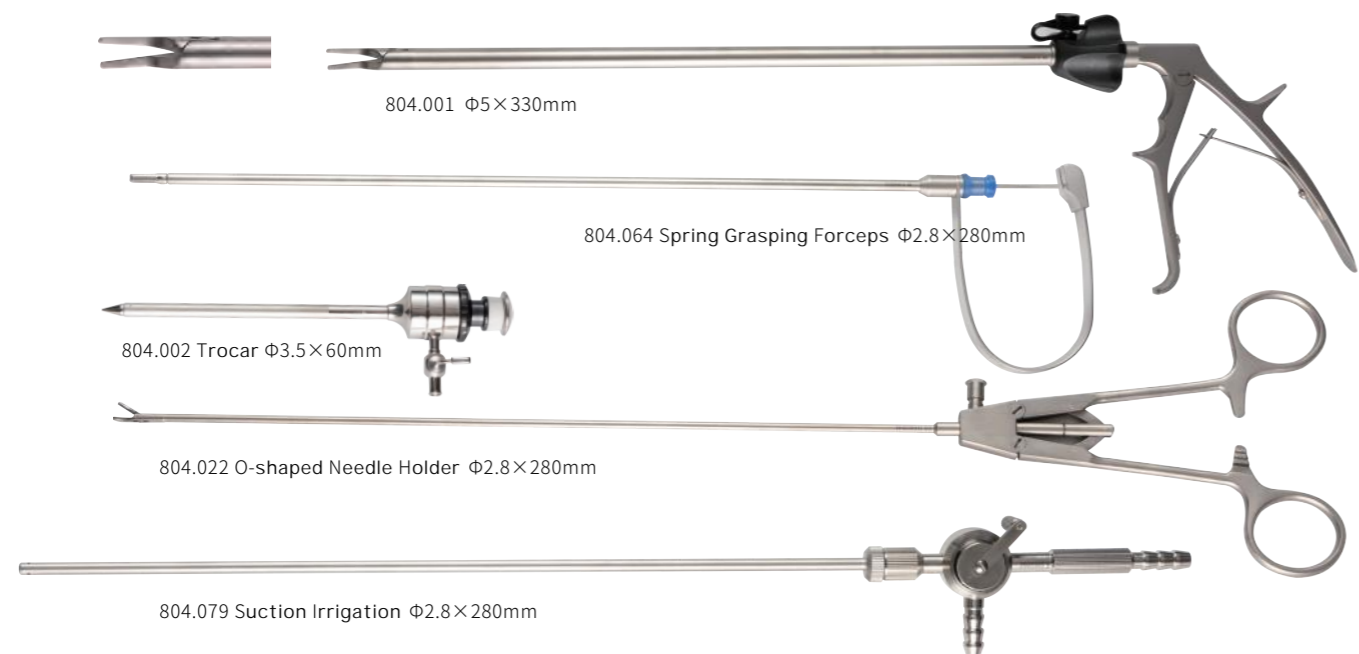

$\Phi 2.8 \times 280\text{mm}$

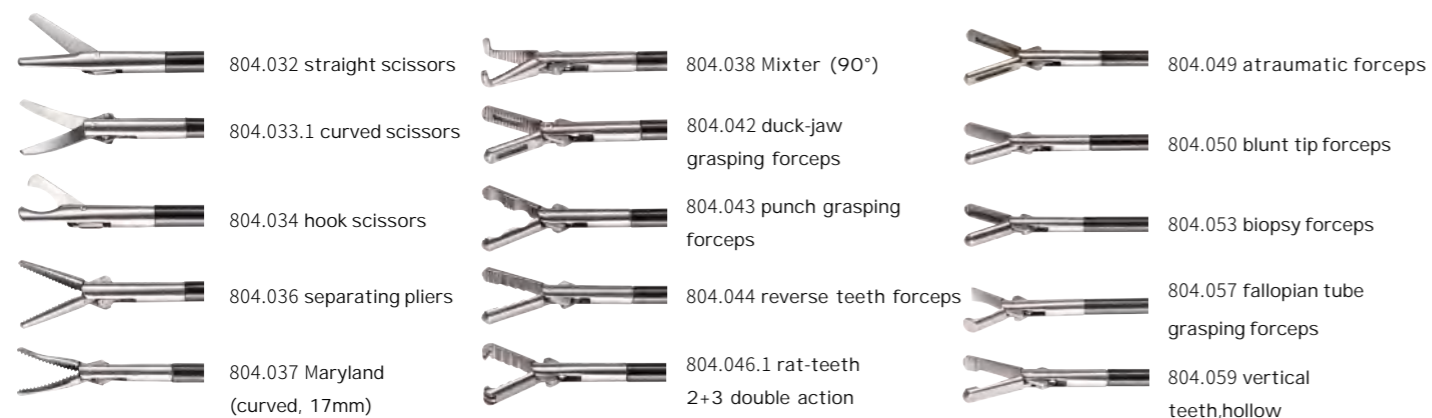
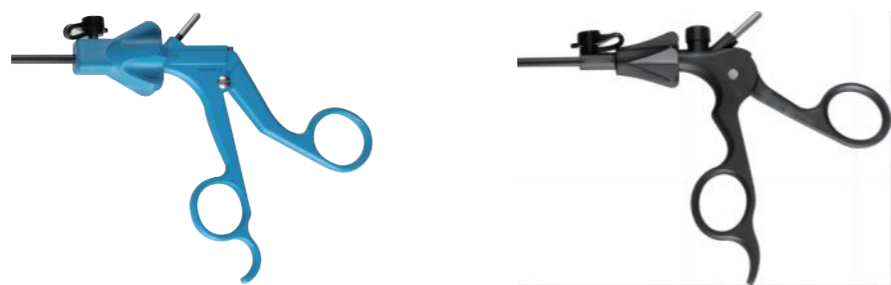

Instrument FOR SILS/Single Port Instruments

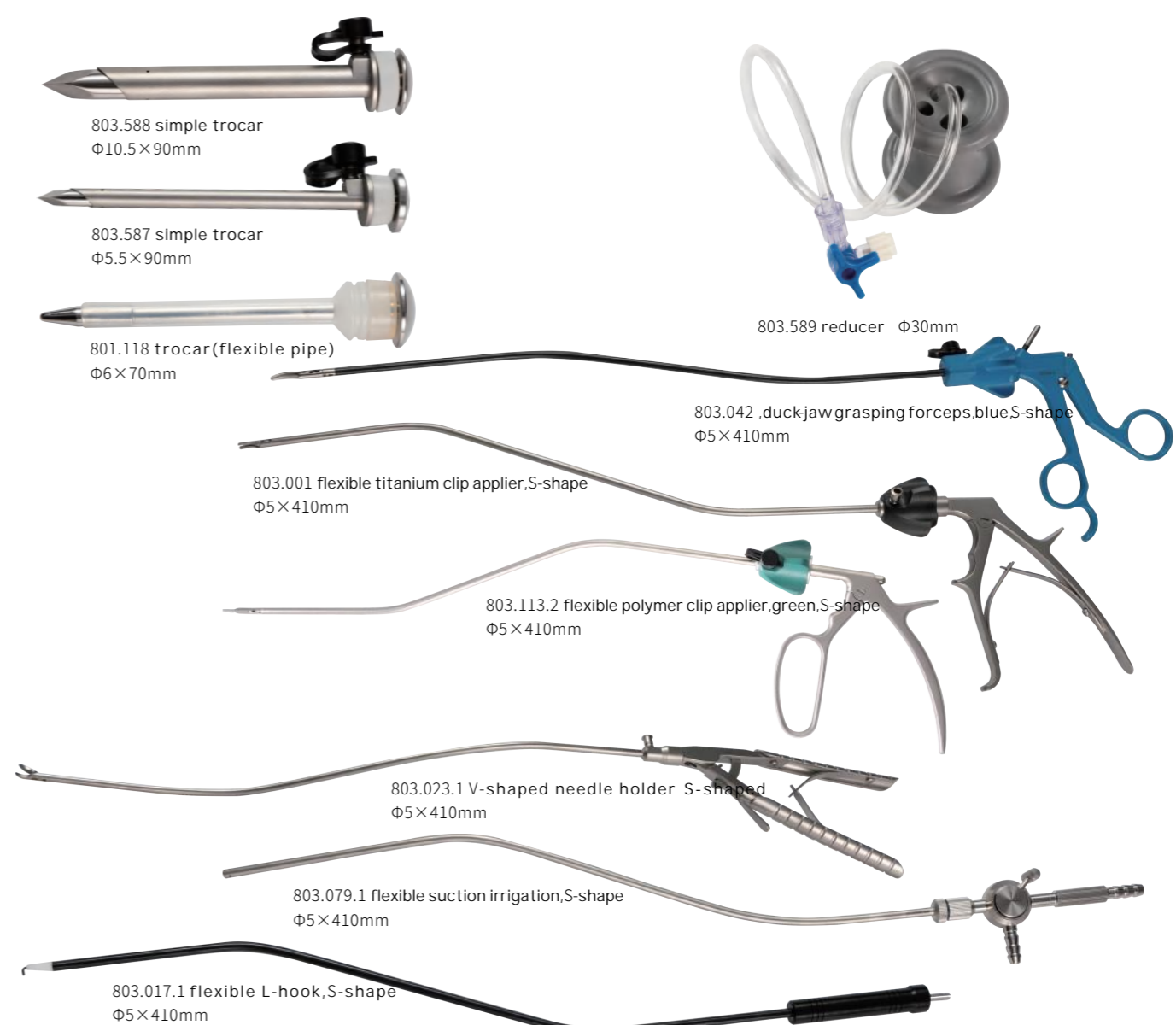

Detachable Picture of Instruments



Thyroid Operating Instrument

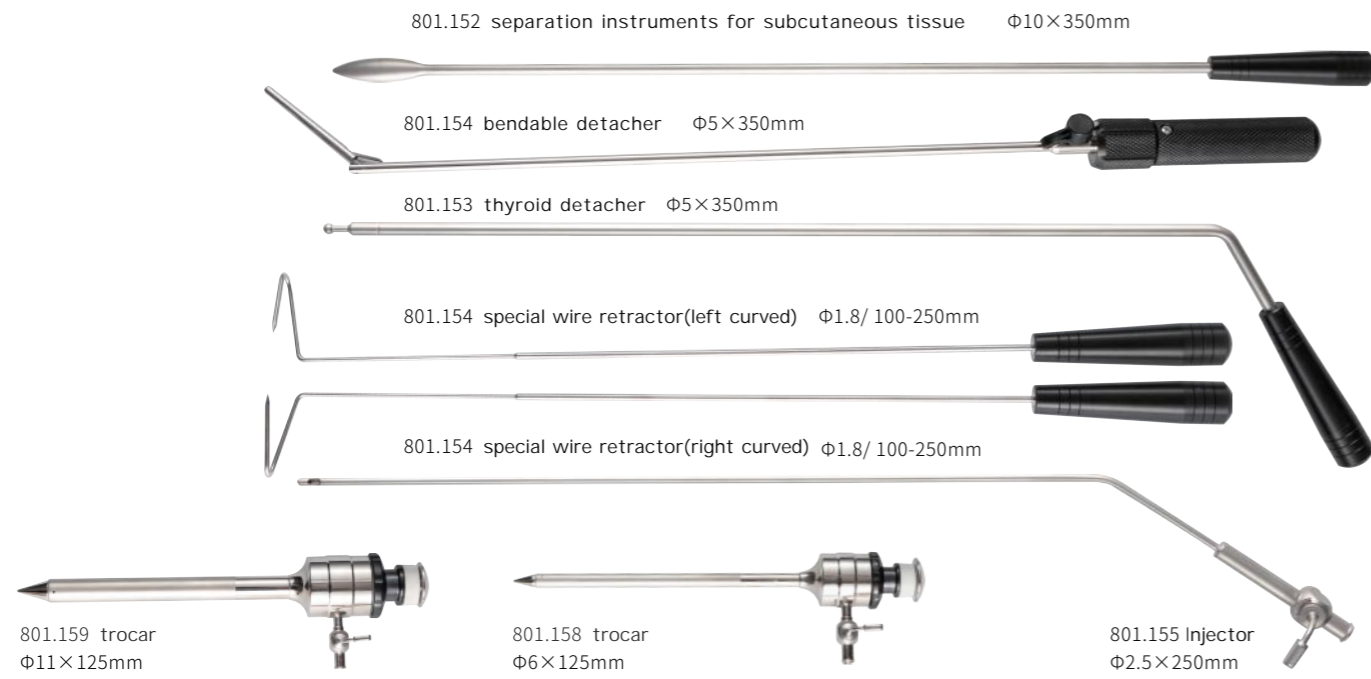

Uterine Manipulator

807.027.2 Uterine Manipulator



807.027.3 Uterine Manipulator



807.072.4 Uterine Manipulator

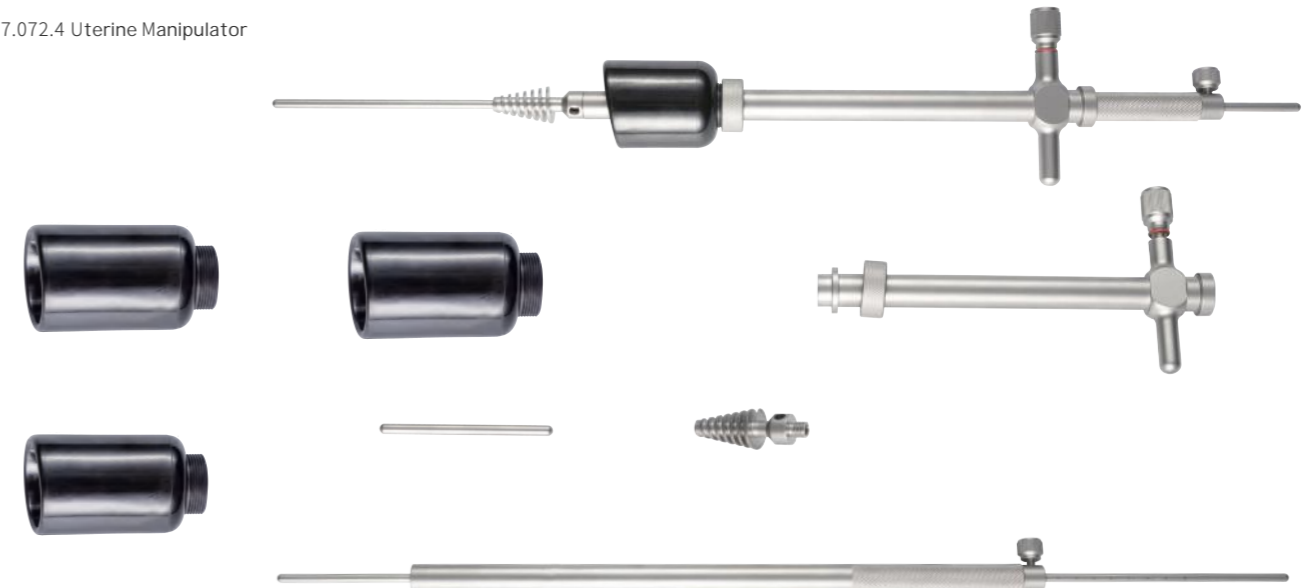

807.027.5 Cup Type Uterine Manipulator



Gynaecology Surgical Instruments

Uterine Manipulator



807.026.1 (7mm)

807.026.2 adjustable
807.026.3 with suction
807.026.4 size:S
807.026.5 size:M
807.026.6 size:L

Uterine Manipulator Set

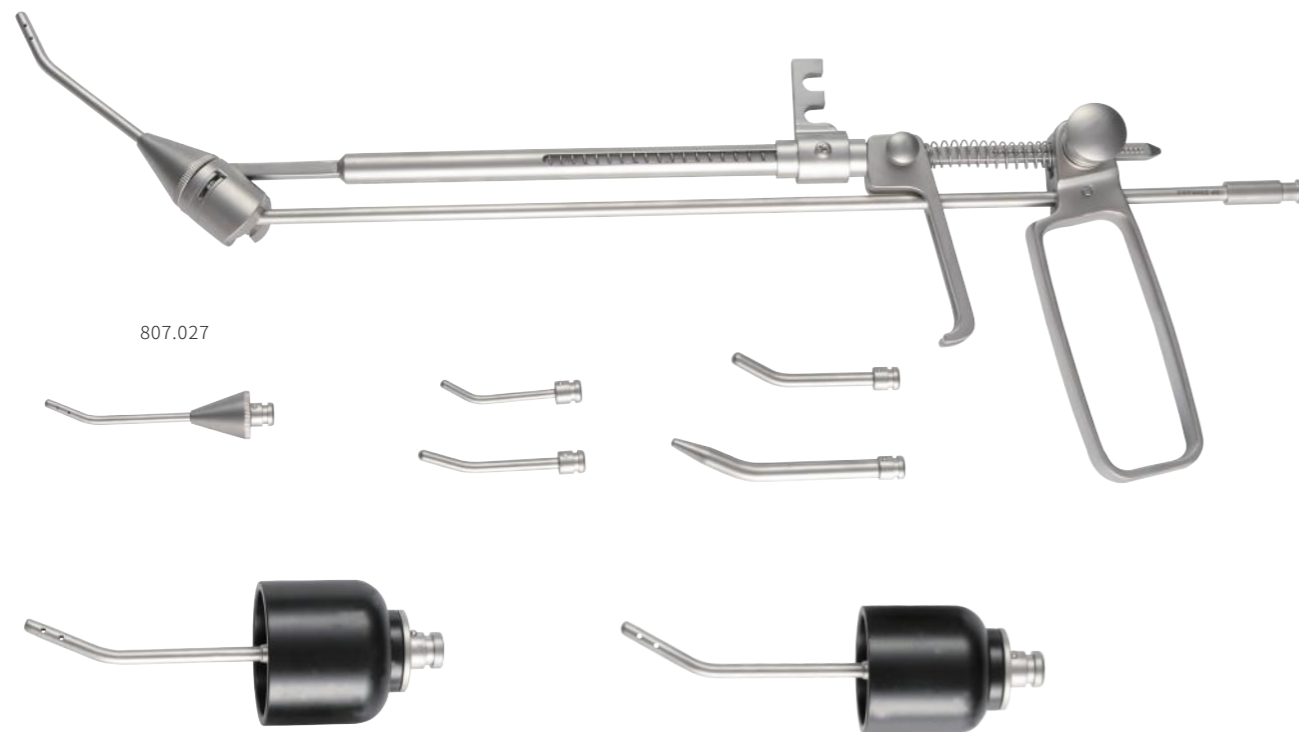

807.027

OC-807 Manipulator



807.001 uterus resector
Φ10×330mm

807.002 uterus resector
Φ15×330mm

807.003 uterus resector
Φ18×330mm

807.004 uterus resector
Φ10×330mm

807.005 uterus resector
Φ15×330mm

807.006 uterus resector
Φ18×330mm



807.007 uterine fixator, Φ5×500mm



801.027 needle
Φ5×330mm



807.013 guide rods
Φ10×370mm



801.029 knot pusher
Φ5×330mm



807.008 pull rod(probe)
Φ5×420mm



807.020 myoma drill
Φ5×420mm



807.021 myoma drill
Φ10×420mm